



indoor air quality and energy saving

TECHNICAL DATA



UTA



VENTILATION UNIT WITH HEAT RECOVERY FOR COMMERCIAL AND INDUSTRIAL BUILDINGS



UTA

Non Residential Ventilation Unit (NRVU) for high air volume.

EQUIPPED

UTA is equipped with high efficiency counterflow heat exchanger (Eurovent certified) and backward blades EC fans.

STRUCTURE

The UTA is composed by three basic modules (two ventilation/filtration modules and a heat recovery/bypass module) which can be easily placed and mounted (fast mechanical and electrical connection). Each module is made of extruded aluminium profiles and double skin zinc magnesium panels, sandwiched on injected polyurethane foam insulation, thickness 45mm. UTA will be delivered with rectangular duct connections. 5 sizes available, all equipped with automatic total bypass. Post heating device (electric or water) and electrical pre heater device are integrated into the unit, while post cooling/heating water coil and direct expansion coil, are available as additional external module. The filtering sections are composed by modules (with standard dimensions) of ePM1 70% (F7) filters for the fresh air flow and ePM10 50% (M5) filters for the extraction air flow. CAV as standard

CONTROLS

UTA is delivered in plug&play configuration. For more informations. For information on this, see the controls technical data.

ACCESSORIES

UTA can be equipped with other accessories such as:

- . recycling module
- . silencer module
- . pre-filters and pocket filters
- . Umidity probe, CO₂ or CO₂ / VOC
- . constant pressure operation kit
- . protection roof for outside instalazione
- . grilles and damper

For a more complete view of the characteristics of the control panels, please read the specific manuals.

UTA STANDARD configuration

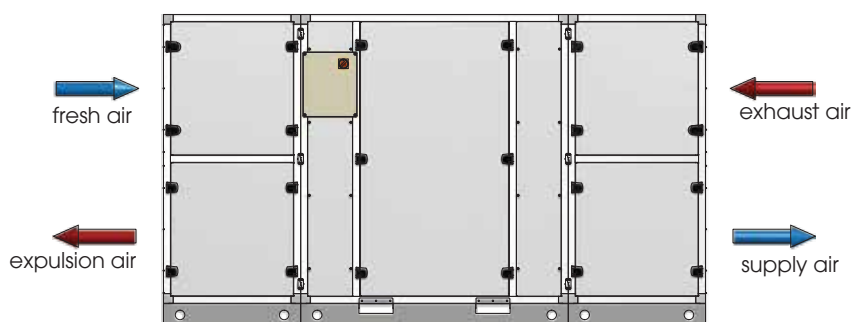

UTA MIRRORED configuration

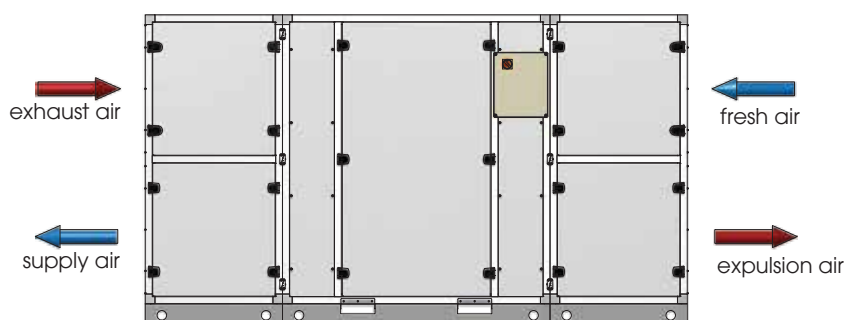

Counterflow heat exchanger made of aluminum manufactured by RECUTECH
RECUTECH participates in the Eurovent Certification Program



PERFORMANCE (UNI EN 13141-7)

The unit must be ducted properly: UTEK authorizes the use only according to its performance diagram shown into this catalogue
The declared performances are with CLEAN filters M5/F7, and guaranteed ONLY with the original filters UTEK low pressure drop.

UTA 1

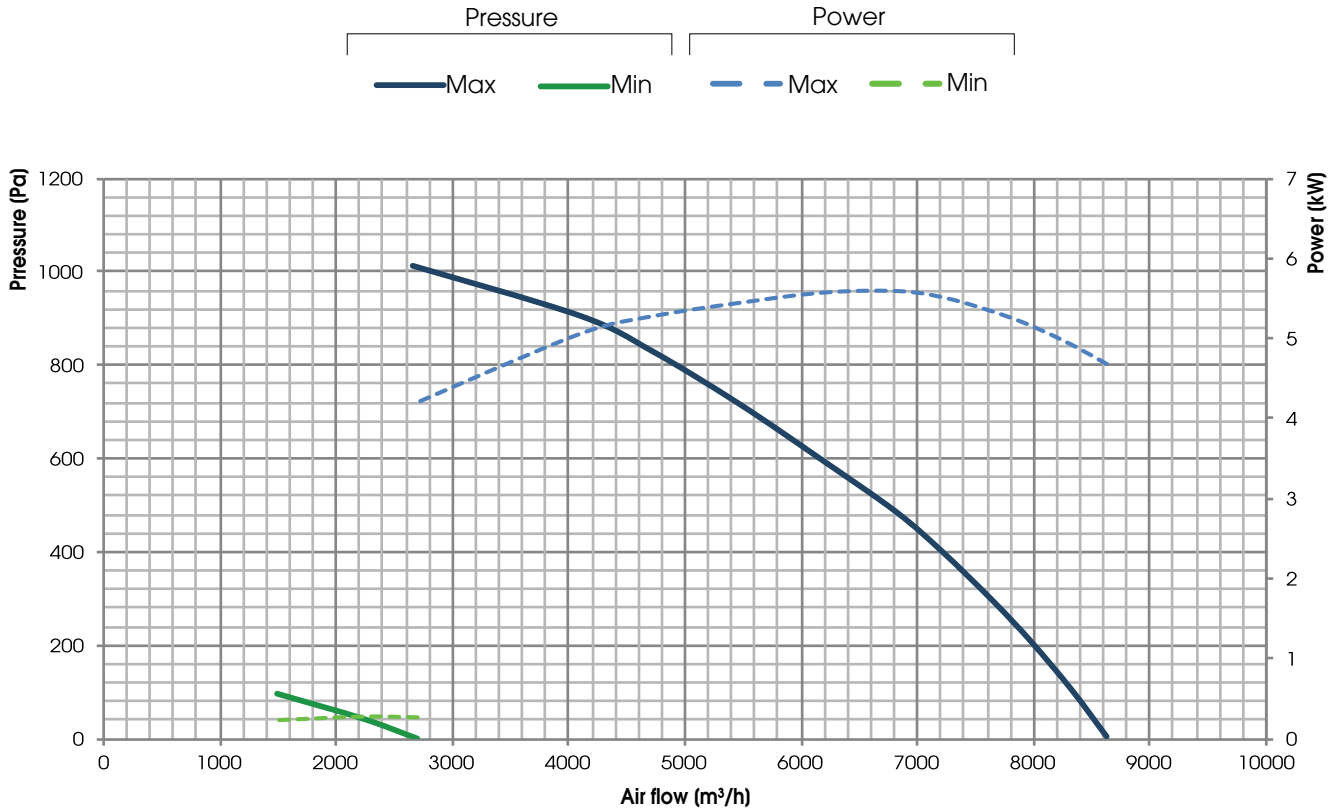

UTA 1+

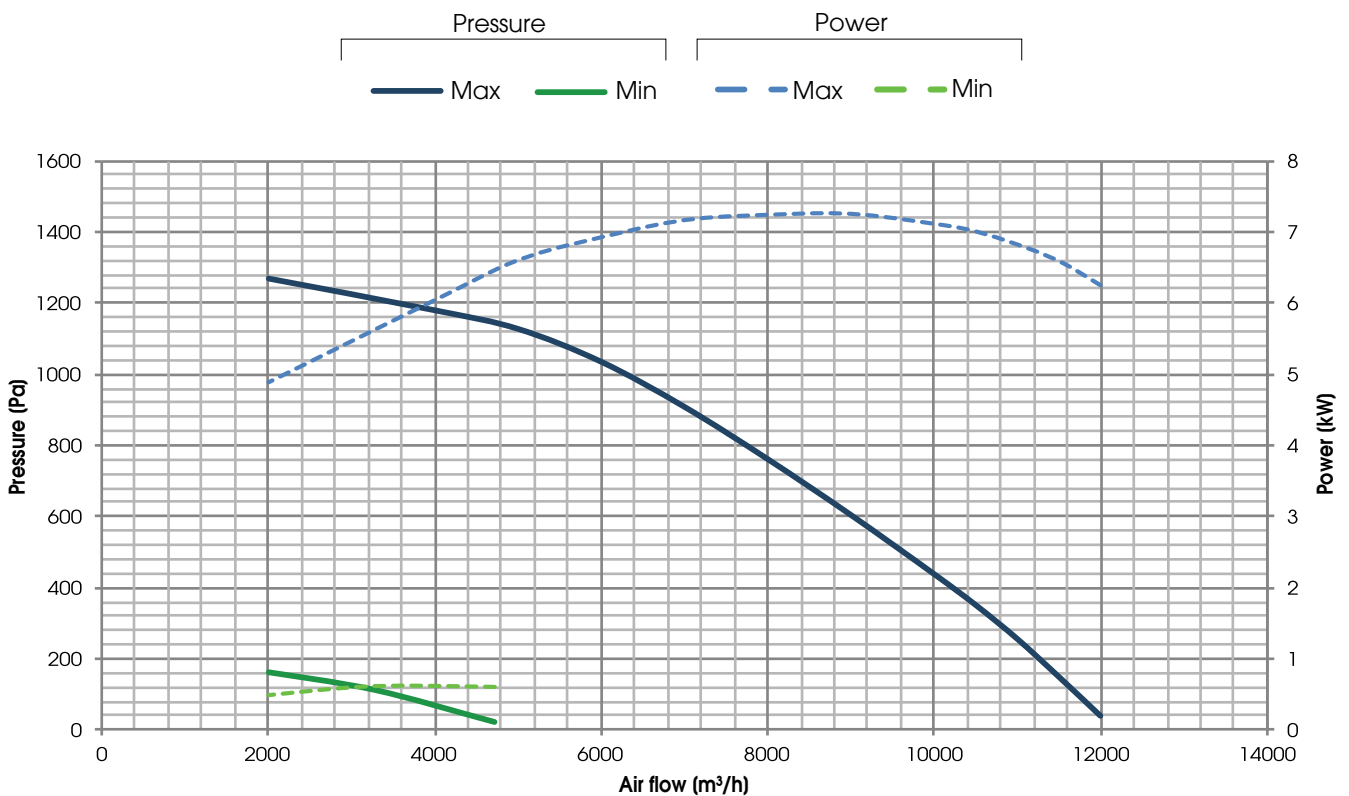



PERFORMANCE (UNI EN 13141-7)

The unit must be ducted properly: UTEK authorizes the use only according to its performance diagram shown into this catalogue
The declared performances are with CLEAN filters M5/F7, and guaranteed ONLY with the original filters UTEK low pressure drop.

UTA 2

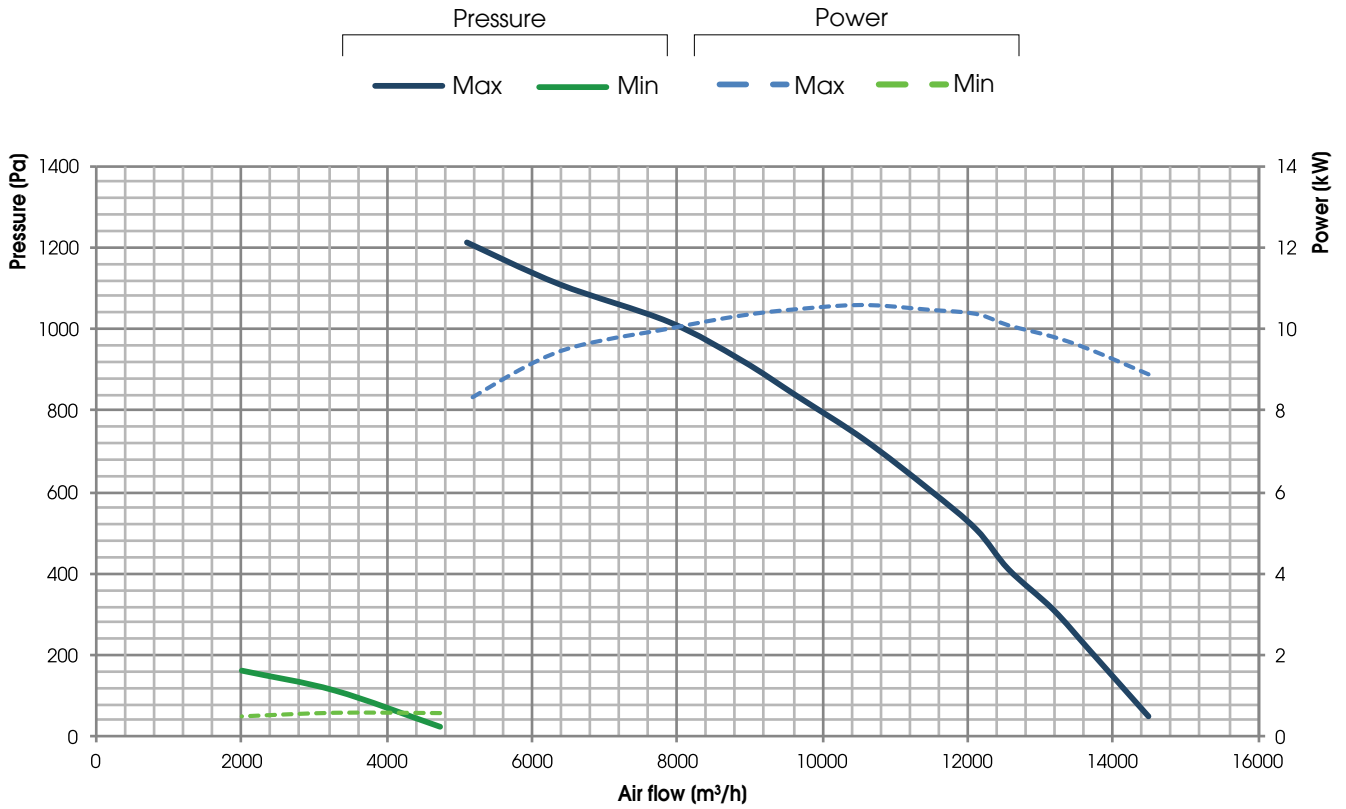

UTA 3

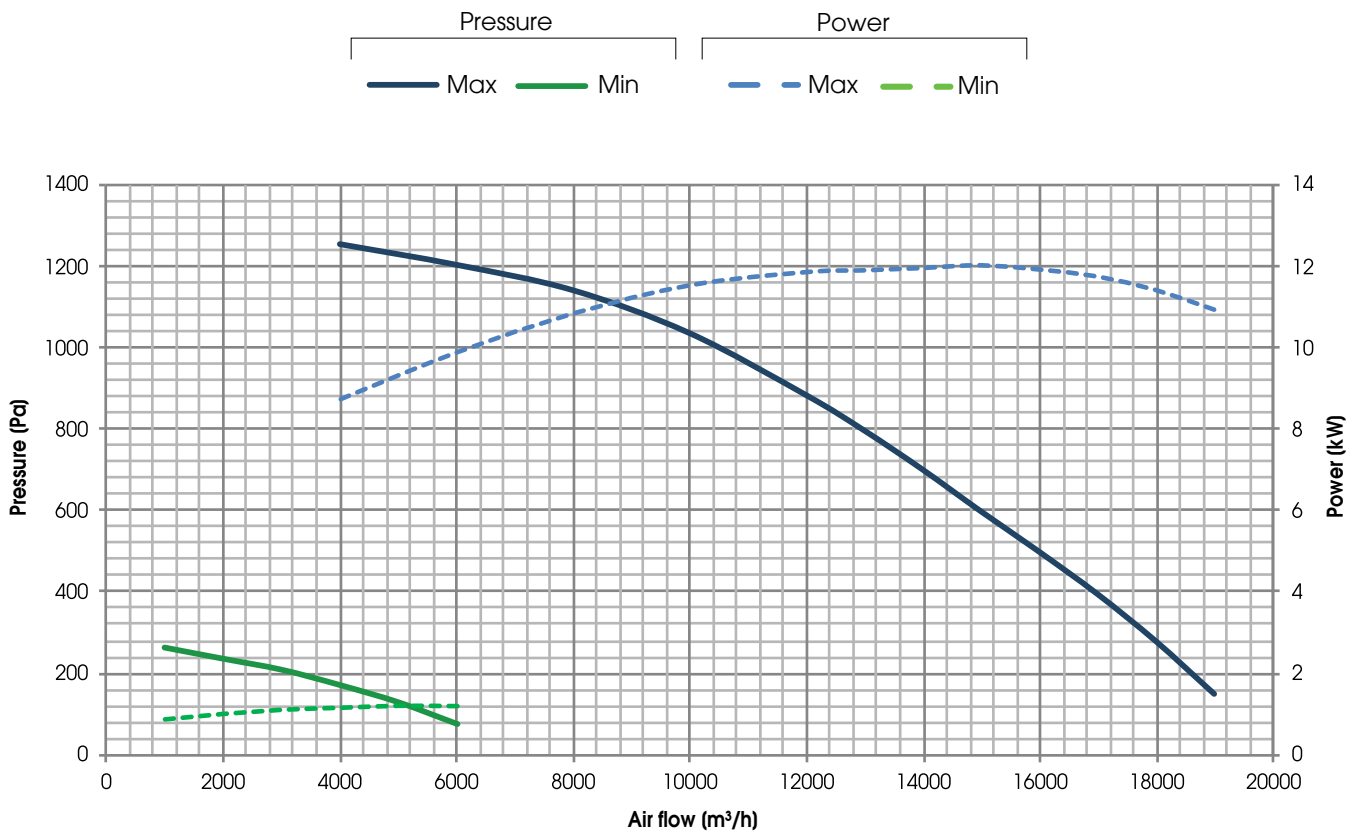



PERFORMANCE (UNI EN 13141-7)

The unit must be ducted properly: UTEK authorizes the use only according to its performance diagram shown into this catalogue
The declared performances are with CLEAN filters M5/F7, and guaranteed ONLY with the original filters UTEK low pressure drop.

UTA 4

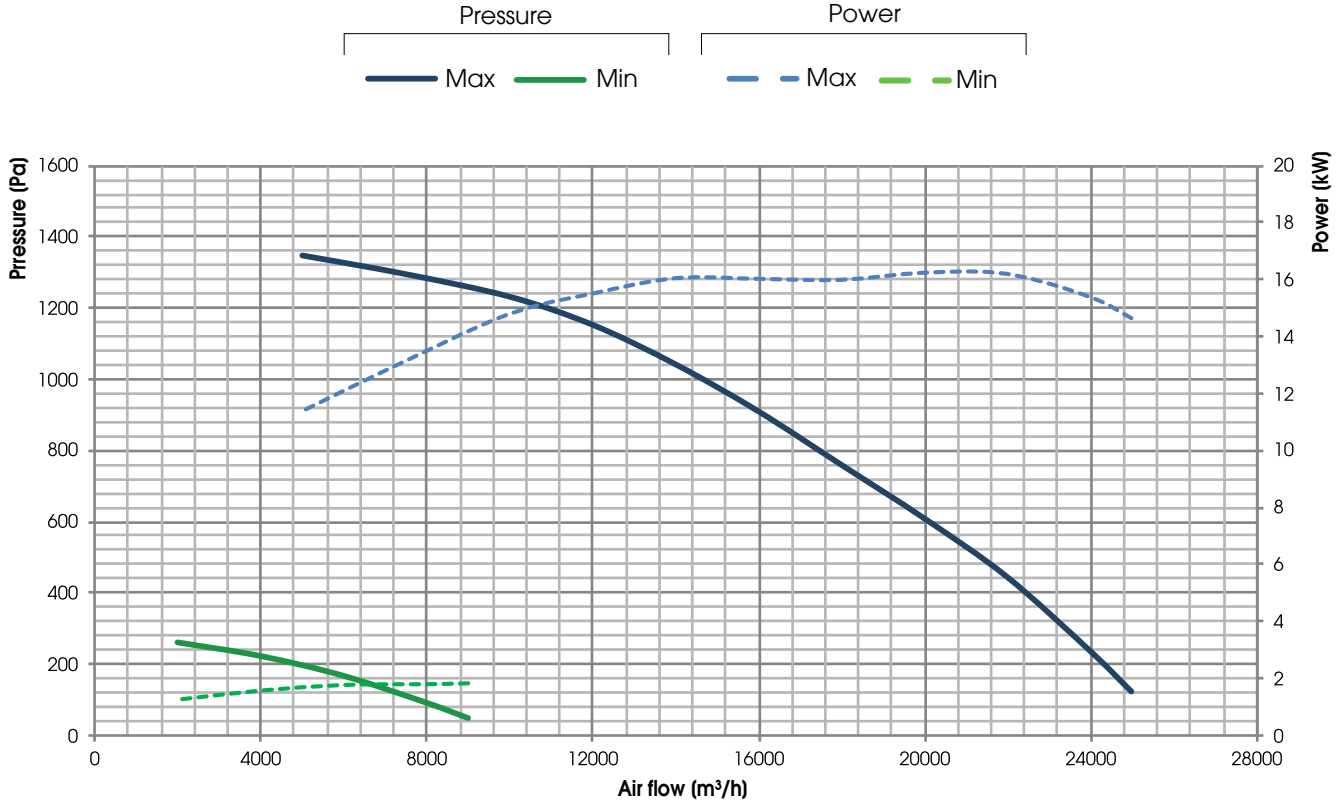

HEAT RECOVERY PERFORMANCE (sensible efficiency)

Values referred to the following conditions (UNI EN 308:1998): T_{bs} external air 5°C; U.R. external 72%; T_{bs} environment 25°C; U.R. environment 38%

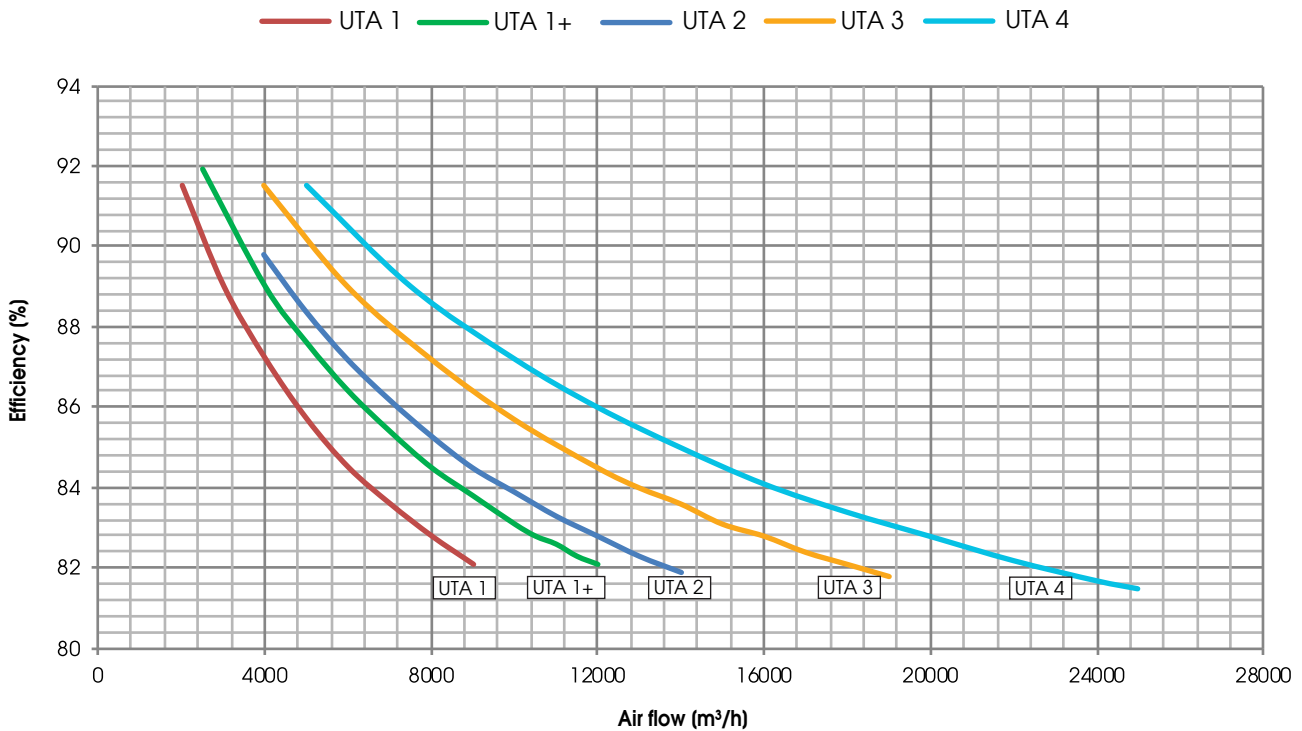



ECODESIGN

UNIT	η_{t_nvr} (%)	q_{nom} (m ³ /s)	$\Delta p_{s,ext}$ (Pa)	P (kW)	SFP _{int} (W/(m ³ /s))	SFP _{int_lim 2016} (W/(m ³ /s))	SFP _{int_lim 2018} (W/(m ³ /s))	FACE VELOCITY(m/s)	$\Delta p_{s,int}$ (Pa)	η_{Fan} (%)	* internal LEAKAGE (%)	* external LEAKAGE (%)
UTA 1	82,8	2,22	200	5,15	1040	1373	1093	2,14	694	62,8	3,4	1,9
UTA 1+	82,4	3,13	200	6,69	1032	1363	1083	2,00	670	65,8	3,4	2,2
UTA 2	82,7	3,38	500	10,36	1085	1370	1090	2,16	704	68,5	3,1	2,0
UTA 3	83,0	4,30	550	11,97	1044	1379	1099	2,07	748	69,0	3,5	2,3
UTA 4	82,6	5,92	500	16,35	1077	1368	1088	2,21	771	68,7	3,4	2,1

* Rispetto a q_{nom}

VALUES ACCORDING UNI EN 1886: 2008

UNIT	CASING STRENGTH	CASING LEAKAGE	FILTER CLASS	THERMAL TRANSMITTANCE	THERMAL BRIDGE
UTA tutte le taglie	D1 (M)	L3 (M)	F7 (M)	T3 (M)	TB3 (M)

TEST LEAKAGE (UNI EN 13141-7)

LEAKAGE	TEST CONDITIONS	UTA 1	UTA 1+	UTA 2	UTA 3	UTA 4
OUTDOOR	Positive pressure 400 Pa	A1	A1	A1	A1	A1
OUTDOOR	Negative pressure 400 Pa	A1	A1	A1	A1	A1
INDOOR	Pressure difference 250 Pa	A2	A2	A2	A2	A2

NOISE LEVEL UTA 1

L_w Sound power level taken in accordance to UNI EN ISO 3747 - CLASS 3

NOISE FROM THE CASE (dB)								
Fans	125 Hz	250 Hz	500 Hz	1000 Hz	2000 Hz	4000 Hz	8000 Hz	L _w dB(A)
100%	71,6	85,3	76,7	70,7	61,7	52,6	57,4	79,2
75%	70,4	80,8	69,5	62,1	53,2	45,9	49,9	73,7
NOISE IN THE SUPPLY AIR DUCTS (dB)								
Fans	125 Hz	250 Hz	500 Hz	1000 Hz	2000 Hz	4000 Hz	8000 Hz	L _w dB(A)
100%	79,9	92,6	92,4	90,6	80,7	73,9	80,8	94,0
75%	78,2	85,6	86,8	82,3	73,3	65,0	73,4	87,0
NOISE IN THE EXPULSION AIR DUCTS (dB)								
Fans	125 Hz	250 Hz	500 Hz	1000 Hz	2000 Hz	4000 Hz	8000 Hz	L _w dB(A)
100%	80,3	93,7	93,0	93,4	82,6	76,1	84,1	96,0
75%	77,9	85,7	87,6	83,4	74,7	66,8	75,7	87,9
NOISE IN THE FRESH AIR DUCTS (dB)								
Fans	125 Hz	250 Hz	500 Hz	1000 Hz	2000 Hz	4000 Hz	8000 Hz	L _w dB(A)
100%	69,3	83,4	74,2	64,7	53,7	47,3	51,4	76,7
75%	67,2	74,1	64,0	53,5	46,5	38,1	54,5	67,3
NOISE IN THE EXHAUST AIR DUCTS (dB)								
Fans	125 Hz	250 Hz	500 Hz	1000 Hz	2000 Hz	4000 Hz	8000 Hz	L _w dB(A)
100%	67,5	82,4	78,1	68,6	56,6	51,9	58,2	78,1
75%	68,6	70,5	69,3	61,1	49,1	43,2	53,1	68,7



NOISE LEVEL UTA 1+

Lw Sound power level taken in accordance to UNI EN ISO 3747 - CLASS 3

NOISE FROM THE CASE (dB)								
Fans	125 Hz	250 Hz	500 Hz	1000 Hz	2000 Hz	4000 Hz	8000 Hz	L _w dB(A)
100%	78,0	81,2	73,7	72,6	66,2	68,0	63,1	78,1
75%	72,3	78,3	67,8	65,3	60,5	61,2	58,9	73,0
NOISE IN THE SUPPLY AIR DUCTS (dB)								
Fans	125 Hz	250 Hz	500 Hz	1000 Hz	2000 Hz	4000 Hz	8000 Hz	L _w dB(A)
100%	79,9	83,3	86,4	85,7	80,6	82,5	79,2	90,2
75%	73,3	81,0	82,1	81,5	77,2	75,3	75,1	85,7
NOISE IN THE EXPULSION AIR DUCTS (dB)								
Fans	125 Hz	250 Hz	500 Hz	1000 Hz	2000 Hz	4000 Hz	8000 Hz	L _w dB(A)
100%	78,0	84,8	86,9	86,1	80,7	83,0	79,4	90,6
75%	74,6	81,9	83,7	81,8	77,0	76,0	75,8	86,3
NOISE IN THE FRESH AIR DUCTS (dB)								
Fans	125 Hz	250 Hz	500 Hz	1000 Hz	2000 Hz	4000 Hz	8000 Hz	L _w dB(A)
100%	73,2	78,6	70,4	67,2	61,4	64,6	51,6	74,3
75%	67,0	74,5	63,7	60,2	55,0	56,0	49,0	68,6
NOISE IN THE EXHAUST AIR DUCTS (dB)								
Fans	125 Hz	250 Hz	500 Hz	1000 Hz	2000 Hz	4000 Hz	8000 Hz	L _w dB(A)
100%	71,7	78,9	65,9	66,4	60,7	63,9	51,8	73,4
75%	67,0	74,5	63,7	60,2	55,0	56,0	49,0	68,6

NOISE LEVEL UTA 2

Lw Sound power level taken in accordance to UNI EN ISO 3747 - CLASS 3

NOISE FROM THE CASE (dB)								
Fans	125 Hz	250 Hz	500 Hz	1000 Hz	2000 Hz	4000 Hz	8000 Hz	L _w dB(A)
100%	75,4	92,3	81,1	75,0	65,4	59,5	61,8	85,3
75%	75,5	80,2	69,9	63,0	54,9	48,6	54,0	73,5
NOISE IN THE SUPPLY AIR DUCTS (dB)								
Fans	125 Hz	250 Hz	500 Hz	1000 Hz	2000 Hz	4000 Hz	8000 Hz	L _w dB(A)
100%	79,6	96,4	93,8	88,5	80,0	75,5	77,9	94,3
75%	77,3	83,7	84,2	79,5	71,7	63,6	70,6	84,5
NOISE IN THE EXPULSION AIR DUCTS (dB)								
Fans	125 Hz	250 Hz	500 Hz	1000 Hz	2000 Hz	4000 Hz	8000 Hz	L _w dB(A)
100%	77,7	97,9	94,3	88,9	80,1	76,0	78,1	95,0
75%	78,6	84,6	85,8	79,8	71,5	64,3	71,3	85,5
NOISE IN THE FRESH AIR DUCTS (dB)								
Fans	125 Hz	250 Hz	500 Hz	1000 Hz	2000 Hz	4000 Hz	8000 Hz	L _w dB(A)
100%	67,1	85,8	77,8	67,4	59,7	52,7	50,5	79,5
75%	68,7	75,0	66,1	56,0	49,1	41,5	42,7	68,5
NOISE IN THE EXHAUST AIR DUCTS (dB)								
Fans	125 Hz	250 Hz	500 Hz	1000 Hz	2000 Hz	4000 Hz	8000 Hz	L _w dB(A)
100%	65,6	86,1	73,3	66,6	59,0	52,0	50,7	78,6
75%	68,1	73,4	64,6	57,9	51,0	42,6	44,1	67,3



NOISE LEVEL UTA 3

Lw Sound power level taken in accordance to UNI EN ISO 3747 - CLASS 3

NOISE FROM THE CASE (dB)								
Fans	125 Hz	250 Hz	500 Hz	1000 Hz	2000 Hz	4000 Hz	8000 Hz	L _w dB(A)
100%	75,5	81,4	72,5	71,8	65,2	60,5	59,6	77,0
75%	71,7	76,7	68,0	67,6	60,0	54,3	51,4	72,4
NOISE IN THE SUPPLY AIR DUCTS (dB)								
Fans	125 Hz	250 Hz	500 Hz	1000 Hz	2000 Hz	4000 Hz	8000 Hz	L _w dB(A)
100%	77,3	84,9	85,0	85,3	79,9	76,1	75,7	88,7
75%	73,7	80,6	80,6	81,0	74,5	70,3	68,3	84,0
NOISE IN THE EXPULSION AIR DUCTS (dB)								
Fans	125 Hz	250 Hz	500 Hz	1000 Hz	2000 Hz	4000 Hz	8000 Hz	L _w dB(A)
100%	77,3	84,9	85,0	85,3	79,9	76,1	75,7	88,7
75%	73,7	80,6	80,6	81,0	74,5	70,3	68,3	84,0
NOISE IN THE FRESH AIR DUCTS (dB)								
Fans	125 Hz	250 Hz	500 Hz	1000 Hz	2000 Hz	4000 Hz	8000 Hz	L _w dB(A)
100%	68,9	77,0	69,2	64,7	59,3	55,2	48,5	71,9
75%	64,9	71,9	64,3	61,2	54,7	48,1	38,5	67,2
NOISE IN THE EXHAUST AIR DUCTS (dB)								
Fans	125 Hz	250 Hz	500 Hz	1000 Hz	2000 Hz	4000 Hz	8000 Hz	L _w dB(A)
100%	68,9	77,0	69,2	64,7	59,3	55,2	48,5	71,9
75%	64,9	71,9	64,3	61,2	54,7	48,1	38,5	67,2

NOISE LEVEL UTA 4

Lw Sound power level taken in accordance to UNI EN ISO 3747 - CLASS 3

NOISE FROM THE CASE (dB)								
Fans	125 Hz	250 Hz	500 Hz	1000 Hz	2000 Hz	4000 Hz	8000 Hz	L _w dB(A)
100%	75,4	92,3	81,1	75,0	65,4	59,5	61,8	85,3
75%	75,5	80,2	69,9	63,0	54,9	48,6	54,0	73,5
NOISE IN THE SUPPLY AIR DUCTS (dB)								
Fans	125 Hz	250 Hz	500 Hz	1000 Hz	2000 Hz	4000 Hz	8000 Hz	L _w dB(A)
100%	79,6	96,4	93,8	88,5	80,0	75,5	77,9	94,3
75%	77,3	83,7	84,2	79,5	71,7	63,6	70,6	84,5
NOISE IN THE EXPULSION AIR DUCTS (dB)								
Fans	125 Hz	250 Hz	500 Hz	1000 Hz	2000 Hz	4000 Hz	8000 Hz	L _w dB(A)
100%	77,7	97,9	94,3	88,9	80,1	76,0	78,1	95,0
75%	78,6	84,6	85,8	79,8	71,5	64,3	71,3	85,5
NOISE IN THE FRESH AIR DUCTS (dB)								
Fans	125 Hz	250 Hz	500 Hz	1000 Hz	2000 Hz	4000 Hz	8000 Hz	L _w dB(A)
100%	67,1	85,8	77,8	67,4	59,7	52,7	50,5	79,5
75%	68,7	75,0	66,1	56,0	49,1	41,5	42,7	68,5
NOISE IN THE EXHAUST AIR DUCTS (dB)								
Fans	125 Hz	250 Hz	500 Hz	1000 Hz	2000 Hz	4000 Hz	8000 Hz	L _w dB(A)
100%	65,6	86,1	73,3	66,6	59,0	52,0	50,7	78,6
75%	68,1	73,4	64,6	57,9	51,0	42,6	44,1	67,3

ELECTRICAL DATA

MATCHING	FANS				UNIT		
	Power(W)	Supply	Current max.(A)	Insulation class	Supply	Current max.(A)	Insulation class
UTA1	2 x 2.900	400V 50/60 Hz 3F	2 x 4,80	IP54 CLASSE B	400V 50 Hz 1F	10,0	IP20
UTA 1+	2 x 3.500	400V 50/60 Hz 3F	2 x 5,30	IP54 CLASSE B	400V 50 Hz 1F	11,0	IP20
UTA 2	2 x 5.200	400V 50/60 Hz 3F	2 x 8,40	IP54 CLASSE B	400V 50 Hz 1F	17,2	IP20
UTA 3	4 x 2.900	400V 50/60 Hz 3F	4 x 4,50	IP54 CLASSE B	400V 50 Hz 1F	18,5	IP20
UTA 4	4 x 4.200	400V 50/60 Hz 3F	4 x 6,40	IP54 CLASSE B	400V 50 Hz 1F	26,1	IP20



UTA DIMENSIONS (mm)

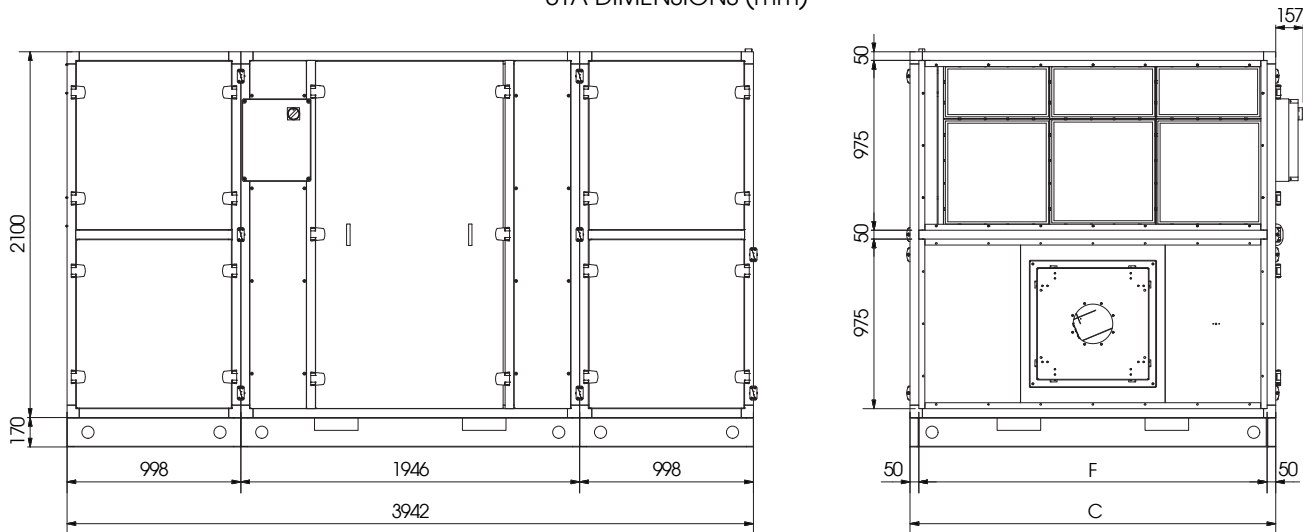

UNIT	C (mm)	F (mm)
UTA 1	1500	1300
UTA 1+	2100	2000
UTA 2	2100	2000
UTA 3	2900	2800
UTA 4	3500	3400

DIMENSIONS (mm) ADDITIONAL MODULES

SINGLE MODULE
 . BA-AF / AC battery
 . DX R410A battery
 . dehumidifies
 . humidifies
 . other use

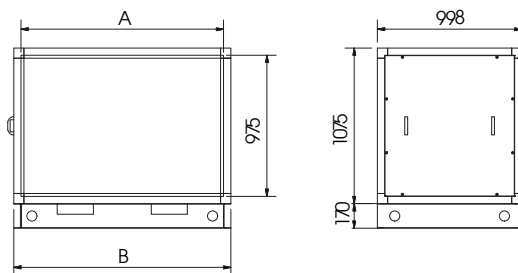

DOUBLE MODULE
 . septa silencers
 (input and extraction)
 . recirculation
 . other use

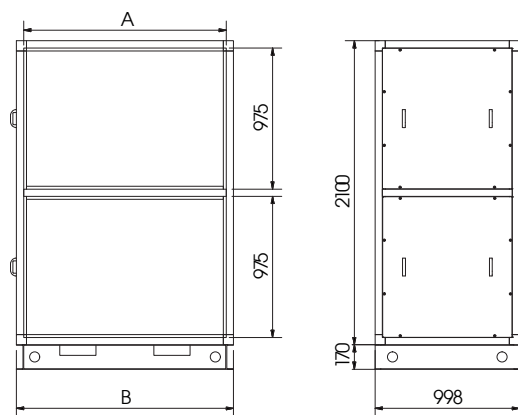

UNIT	Dimensions (mm)	Reference
UTA 1	1400	A
UTA 1	1500	B
UTA 1+	2000	A
UTA 1+	2100	B
UTA 2	2000	A
UTA 2	2100	B
UTA 3	2800	A
UTA 3	2900	B
UTA 4	3400	A
UTA 4	3500	B



DIMENSIONS (mm) & WEIGHTS (kg) UTA for SHIPPING and POSITIONING

For shipping and positioning reasons, UTA is supplied in 3 modules designed for quick connections (mechanical and electrical) on site.
The presence of H2O cold / hot coil, silencers septa, or empty modules (e.g. humidifier positioning) involves additional modules

UTA 1	Pieces	Dimensions (mm)			Weight (kg)		
		Width	Length	Height	Pallet	Net	Gross
UTA 1	1	1750	2150	2380	71	555	626
	1	1750	1200	2380	41	187	228
	1	1750	1200	2380	41	187	228
UTA 1 + BA-AC	1	1750	2150	2380	71	555	626
	1	1750	1200	2380	41	187	228
	1	1750	1200	2380	41	219	260
UTA 1 + REL-T (PRE or POST)	1	1750	2150	2380	71	555	626
	1	1750	1200	2380	41	187	228
	1	1750	1200	2380	41	203	244
BA-AF module	1	1750	1200	1350	41	156	197
SILENCERS module	1	1750	1200	2380	41	156	197

UTA 1+ and 2	Pieces	Dimensions (mm)			Weight (kg)		
		Width	Length	Height	Pallet	Net	Gross
UTA 1+ and 2	1	2370	2150	2380	86	854	940
	1	2370	1200	2380	47	256	303
	1	2370	1200	2380	47	256	303
UTA 1+2 + BA-AC	1	2370	2150	2380	86	854	940
	1	2370	1200	2380	47	256	303
	1	2370	1200	2380	47	306	353
UTA 1+2 + REL-T (PRE or POST)	1	2370	2150	2380	86	854	940
	1	2370	1200	2380	47	256	303
	1	2370	1200	2380	47	274	321
BA-AF module	1	2370	1200	1350	47	204	251
SILENCERS module	1	2370	1200	2380	47	289	336

UTA 3	Pieces	Dimensions (mm)			Weight (kg)
		Width	Length	Height	
UTA 3	1	3100	2000	2300	960
	2	3000	1000	2300	422
UTA 3 + BA-AC	1	3000	1000	1250	271
UTA 3 + BA-AT	1	3000	1000	1250	303
BA-AF module	1	3000	1000	1250	328
SILENCERS module	1	3000	1000	2300	564

UTA 4	Pieces	Dimensions (mm)			Weight (kg)
		Width	Length	Height	
UTA 4	1	3700	2000	2300	1106
	2	3600	1000	2300	483
UTA 3 + BA-AC	1	3600	1000	1250	303
UTA 3 + BA-AT	1	3600	1000	1250	342
BA-AF module	1	3600	1000	1250	380
SILENCERS module	1	3600	1000	2300	615



RECIRCULATION MODULE

Made with 45 mm insulated panels, like the recuperator; equipped with 3 motorized dampers : one on expulsion air, one on renewal, the third puts in communication air of recovery and input.

It uses the energy content (temperature) of the air in the room and re-enters it, decreasing the load of the primary heating / cooling system. When the fan motors are stopped, the dampers on expulsion and renewal close the vents to prevent hot air outflows

Modulating damper motors (0-10 Volt signal) can be operated by an air quality probe positioned on the return duct (average of the values of the different environments) or inside a "master" room. As the CO₂ concentration in the rooms rises, the amount of external air will be increased, because two dampers open (plus external air) and one closes (less recirculation), with the aim of lowering the CO₂ bringing it back to optimal values.

Alternatively, temperature or other external signal management (0-10 Volt signal required)

CLOSED RECIRCULATION MODULE

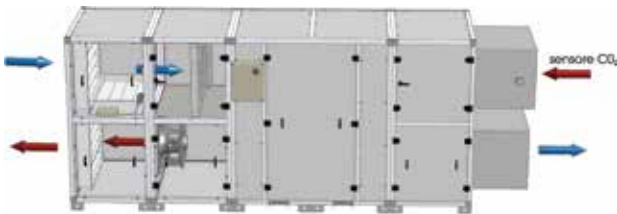

OPEN RECIRCULATION MODULE

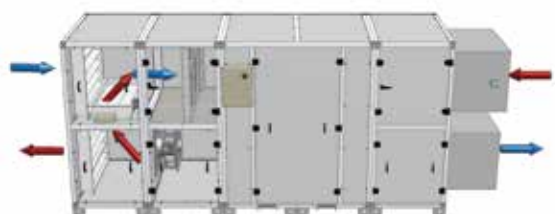

UTA FLOOR INSTALLATION

 Minimum required space for maintenance (mm)

NOTE: for outdoor installation, provide a roof (see price list)

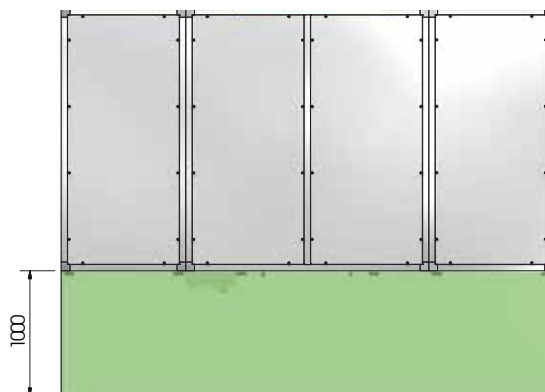
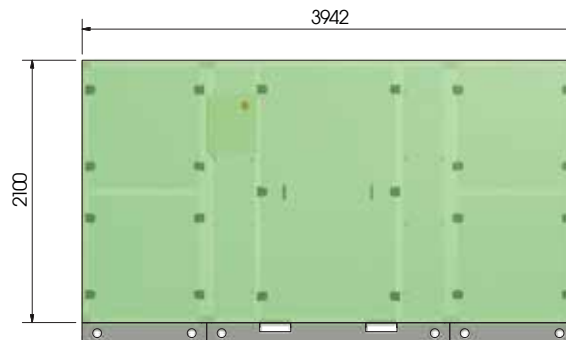



FILTERRS OPTIONS

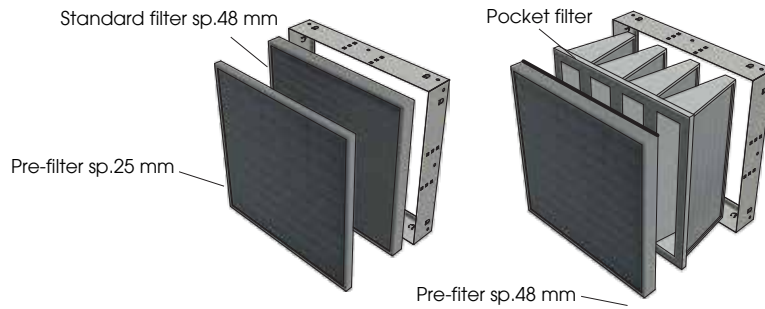

NOTE: for the use of bag filters and pre-filters, contact the Technical Department for the pressure drop values

BA-AC COIL (Outside air -5°C 80% - Inside air 20°C 50%)

Water 70-60°C	Unit	Air flow (m³/h)	Air IN	Power (kW)	Temp out (°C)	DP air (Pa)	Water flow (l/h)	DP water (kPa)	Ø connections	Vol (l)
	UTA 1	7000	17,1°C 17% U.R.	34,6	31,6	15	3034	5,4	1"	8,4
UTA 1+	10000	17,0°C 17% U.R.	37,9	28,1	12	3326	13,8	1"	6,5	
UTA 2	12500	16,9°C 18% U.R.	58,5	30,7	20	5136	16,9	1" 1/4	12,3	
UTA 3	16000	16,9°C 18% U.R.	87,5	33,0	22	7684	23,5	1" 1/4	16,1	
UTA 4	22000	16,8°C 18% U.R.	113,8	32,0	26	9989	21,8	1" 1/4	19,4	

Water 50-40°C	Unit	Air flow (m³/h)	Air IN	Power (kW)	Temp out (°C)	DP air (Pa)	Water flow (l/h)	DP water (kPa)	Ø connections	Vol (l)
	UTA 1	7000	17,1°C 17% U.R.	18,8	25,0	15	2338	3,3	1"	8,4
UTA 1+	10000	17,0°C 17% U.R.	20,5	23,0	12	1781	4,3	1"	6,5	
UTA 2	12500	16,9°C 18% U.R.	32,5	24,6	20	2831	6,6	1" 1/4	12,3	
UTA 3	16000	16,9°C 18% U.R.	48,8	25,9	22	4249	8,0	1" 1/4	16,1	
UTA 4	22000	16,8°C 18% U.R.	63,3	25,3	26	5507	7,4	1" 1/4	19,4	

BA-AT COIL (Outside air -5°C 80% - Inside air 20°C 50%)

Water 60-50°C	Unit	Air flow (m³/h)	Air IN	Power (kW)	Temp out (°C)	DP air (Pa)	Water flow (l/h)	DP water (kPa)	Ø connections	Vol (l)
	UTA 1	7000	17,1°C 17% U.R.	44,6	35,9	30	3900	10,7	1"	11,9
UTA 1+	10000	17,0°C 17% U.R.	72,1	38,2	27	6303	31,0	1" 1/4	17,5	
UTA 2	12500	16,9°C 18% U.R.	82,3	36,4	39	7191	45,3	1" 1/4	17,5	
UTA 3	16000	16,9°C 18% U.R.	134,7	41,7	47	11774	63,1	1" 1/4	33,8	
UTA 4	22000	16,8°C 18% U.R.	179,3	40,8	56	15668	57,3	1" 1/4	41,1	

Water 45-35°C	Unit	Air flow (m³/h)	Air IN	Power (kW)	Temp out (°C)	DP air (Pa)	Water flow (l/h)	DP water (kPa)	Ø connections	Vol (l)
	UTA 1	7000	17,1°C 17% U.R.	25,7	27,9	29	2230	3,9	1"	11,9
UTA 1+	10000	17,0°C 17% U.R.	42,4	29,5	26	3681	13,3	1" 1/4	17,5	
UTA 2	12500	16,9°C 18% U.R.	48,2	28,3	39	4183	19,2	1" 1/4	17,5	
UTA 3	16000	16,9°C 18% U.R.	80,3	31,7	46	6976	33,1	1" 1/4	33,8	
UTA 4	22000	16,8°C 18% U.R.	106,1	31,0	55	9213	22,2	1" 1/4	41,1	

BA-AF COIL

Outside air 34°C 40% - Inside air 26°C 50%

Water 60-50°C	Unit	Air flow (m³/h)	Air IN	Power (kW)	Temp out (°C)	DP air (Pa)	Water flow (l/h)	DP water (kPa)	Ø connections	Vol (l)
	UTA 1	7000	27,3°C 59% U.R.	42,2	16,0	51	7404	8,2	1" 1/2	19,3
UTA 1+	10000	27,4°C 58% U.R.	51,8	17,5	34	8994	13,3	1" 1/2	18,9	
UTA 2	12500	27,4°C 58% U.R.	76,8	15,9	51	13485	34,1	2"	29	
UTA 3	16000	27,4°C 58% U.R.	92,3	16,5	52	16339	25,4	2"	37,5	
UTA 4	22000	27,4°C 58% U.R.	131,9	16,1	71	23205	24,9	2" 1/2	46,7	

Outside air -5°C 80% - Inside air 20°C 50%

Water 45-35°C	Unit	Air flow (m³/h)	Air IN	Power (kW)	Temp out (°C)	DP air (Pa)	Water flow (l/h)	DP water (kPa)	Ø connections	Vol (l)
	UTA 1	7000	17,1°C 17% U.R.	32,5	30,8	40	2821	1,2	1" 1/2	19,3
UTA 1+	10000	17,0°C 17% U.R.	38,9	28,4	26	3378	1,9	1" 1/2	18,9	
UTA 2	12500	16,9°C 18% U.R.	57,9	30,5	53	5023	4,8	2"	29,0	
UTA 3	16000	16,9°C 18% U.R.	68,7	29,5	41	5962	3,5	2"	37,5	
UTA 4	22000	16,8°C 18% U.R.	99,5	30,1	55	8641	3,5	2" 1/2	46,7	



UTA SILENCER - double module (silenced inlet and outlet)

	ATTENUATION (dB)						
	125 Hz	250 Hz	500 Hz	1000 Hz	2000 Hz	4000 Hz	8000 Hz
SILENCER UTA 1	5	13	18	24	22	13	8
SILENCER UTA 1+/2	5	15	21	27	25	15	9
SILENCER UTA 3	5	13	18	24	22	13	8
SILENCER UTA 4	5	14	20	26	24	14	8

— UTA1 — UTA1+/2 — UTA 3 — UTA 4

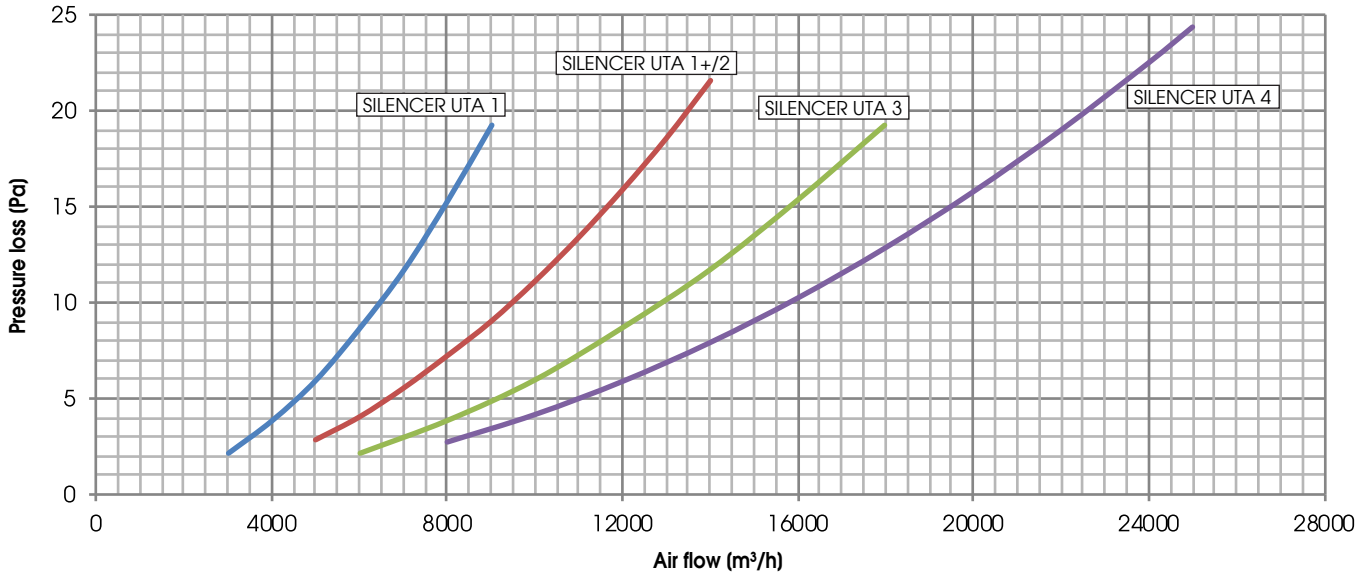

POSITIONING OF GRIDS AND DAMPERS

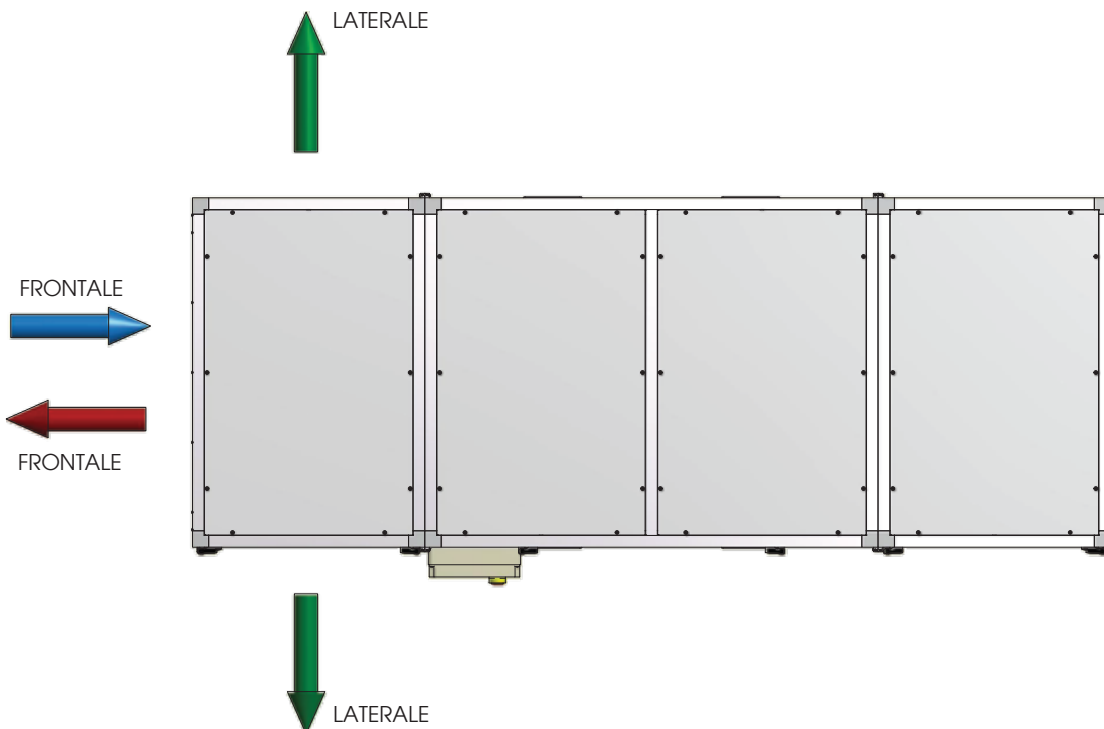

NOTE: LATERAL only 1, 1+ and 2



RETURN GRID

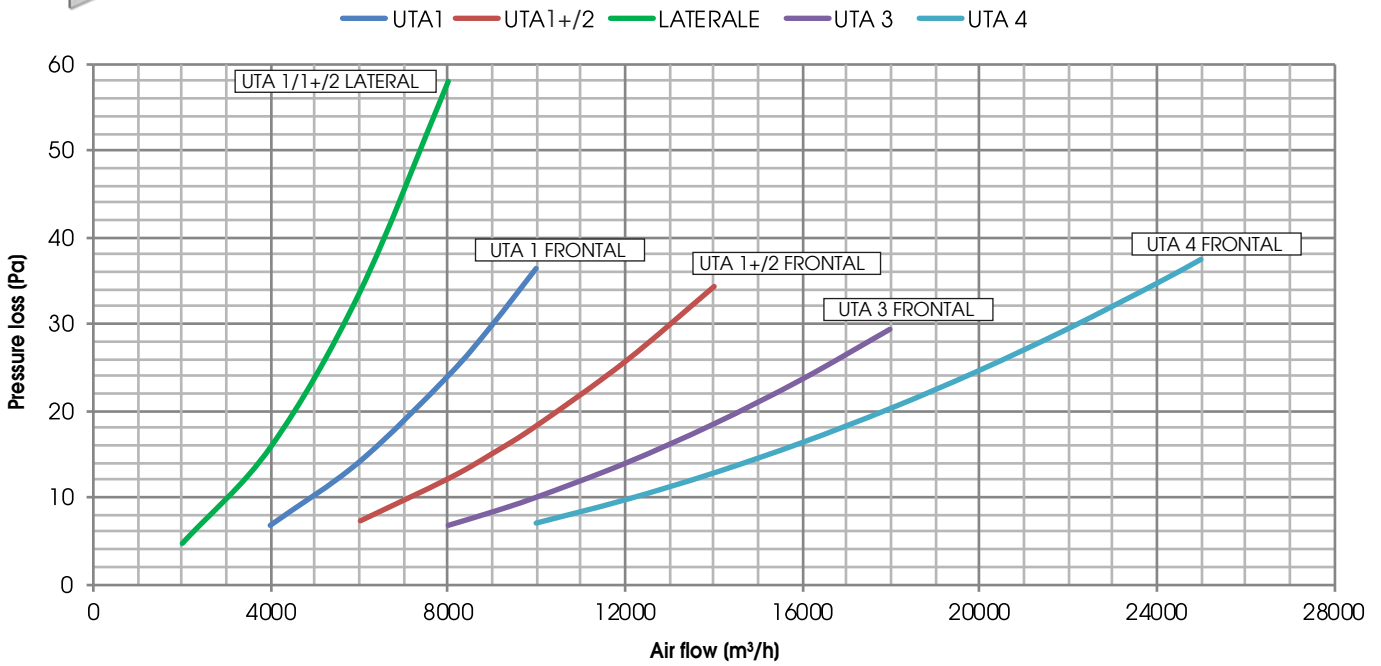

GRIGLIA AFONICA



DAMPING (dB)						
125 Hz	250 Hz	500 Hz	1000 Hz	2000 Hz	4000 Hz	8000 Hz
6	8	10	14	18	16	15

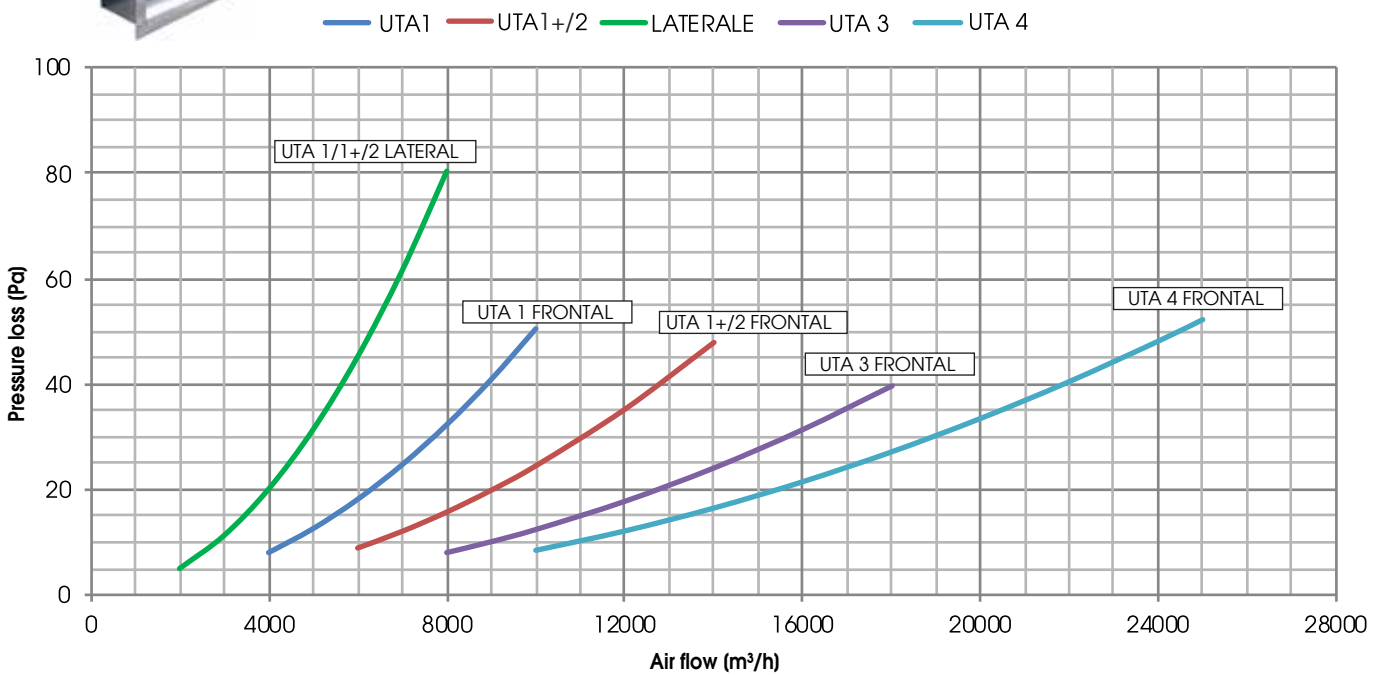



OVERPRESSURE DAMPER

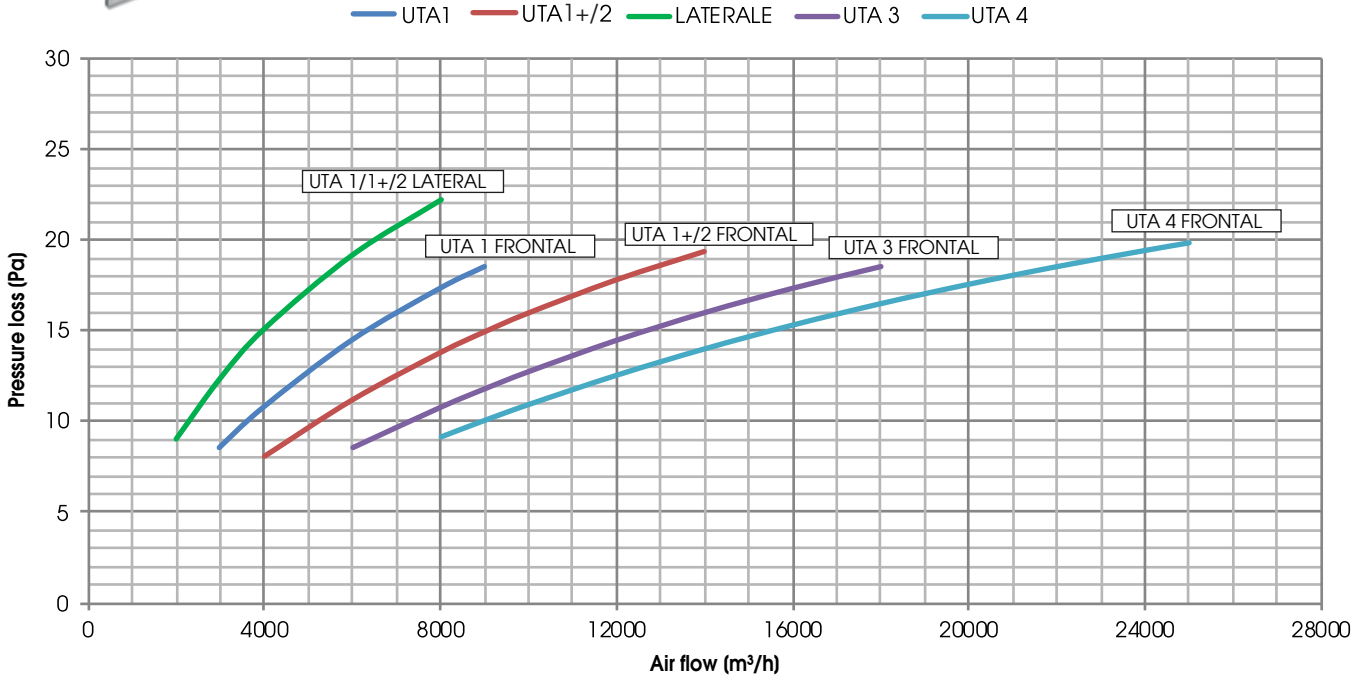

RETURN GRILLE WITH ADJUSTABLE FINS

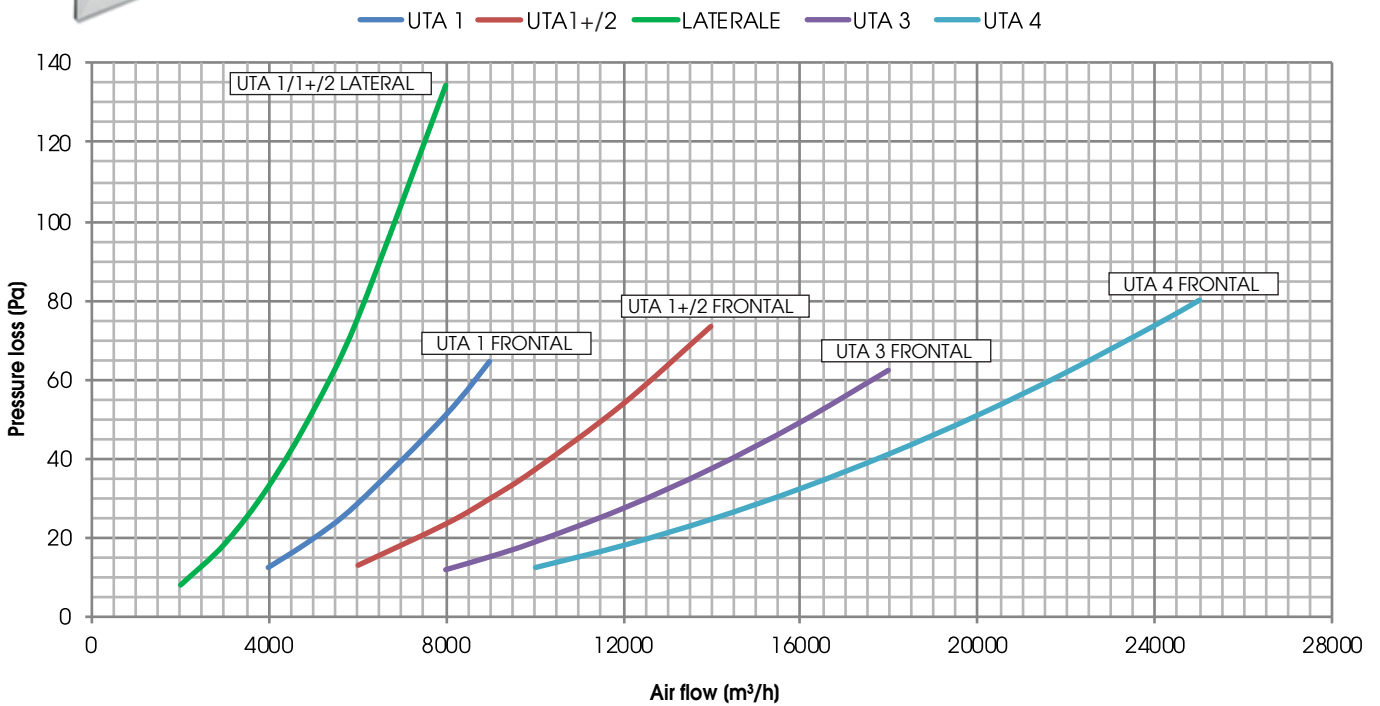

For more info contact the technical office tecnico@cla-utek.it

A	Manufacturer's name	C.L.A. S.r.l.				
B	Manufacturer's model identifier	UTA 1 BP CAV	UTA 1 + BP CAV	UTA 2 BP CAV	UTA 3 BP CAV	UTA 4 BP CAV
C	Declared typology	UVNR / UVB	UVNR / UVB	UVNR / UVB	UVNR / UVB	UVNR / UVB
D	Type of drive installed	Variable speed	Variable speed	Variable speed	Variable speed	Variable speed
E	Type of HRS	other	other	other	other	other
F	Thermal efficiency of heat recovery (%)	82,8	82,4	82,7	83,0	82,6
G	Nominal NRVU flow rate (m³/s)	2,22	3,13	3,38	4,3	5,9
H	Effective electric power input (kW)	5,15	6,69	10,36	12,0	16,4
I	SFPint (W/(m³/s)	1040	1032	1085	1044	1077
J	Face velocity at design flow rate (m/s)	2,14	2,00	2,16	2,07	2,21
K	Nominal external pressure (Pa)	200	200	500	550	500
L	Internal pressure drop of ventilation components (Pa)	694	670	704	748	771
M	Optional: internal pressure drop of non-ventilation components	-	-	-	-	-
N	Static efficiency of fans used in accordance with Regulation (EU) No 327/2011 (%)	62,8	65,8	68,5	69,0	68,7
O	Declared maximum external leakage rate of the casing of ventilation units (%)	1,9	2,2	2,0	2,3	2,1
O	Declared maximum internal leakage rate of bidirectional ventilation units or carry over (for regenerative heat exchangers only) (%)	3,4	3,4	3,1	3,5	3,4
P	Energy performance, preferably energy classification, of the filters (declared information about the calculated annual energy consumption	ePM1 70% (F7)/ ePM10 50% (M5)	ePM1 70% (F7)/ ePM10 50% (M5)	ePM1 70% (F7)/ ePM10 50% (M5)	ePM1 70% (F7)/ ePM10 50% (M5)	ePM1 70% (F7)/ ePM10 50% (M5)
Q	Position and description of visual filter warning for RVUs intended for use with filters, including text pointing out the importance of regular filter changes for performance and energy efficiency of the unit	Filter warning is signaled on the display of the control system: the flashing writing "DirtyFilters" will appear. "To preserve the energy efficiency of the NRVU, it's recommended to replace the filters when signaled." Positioned near the filters inspection				
R	Casing sound power level (LWA) (dB)	79	78	85	77	85
S	Internet address for pre-/dis-assembly instructions	www.utek-air.it				

CLA & UTEK reserves the right to at any time the necessary changes to improve products without prior notice .

Dear Customer
Thanks for your attention to the product UTEK,
designed and manufactured to ensure the real
values to the User : Quality, Safety and Savings on
working.



Made in Italy

**AZIENDA CON SISTEMA
DI GESTIONE QUALITÀ
CERTIFICATO DA DNV GL
ISO 9001**

**AZIENDA CON
SISTEMA DI GESTIONE
AMBIENTALE CERTIFICATO
DA DNV
ISO 14001**

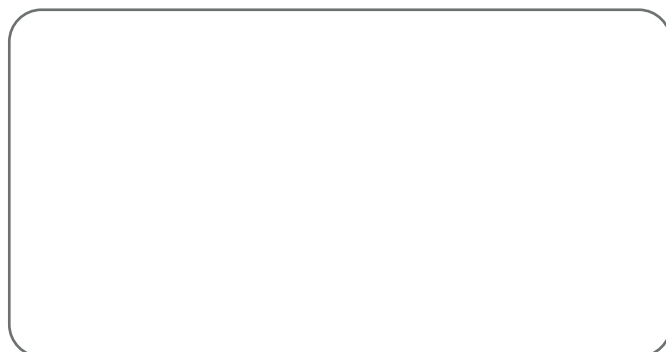

the Dealer

UTA_2020_2_EN



VENTILATION UNIT WITH HEAT RECOVERY FOR COMMERCIAL AND INDUSTRIAL BUILDINGS